

AURATON

R30 RT

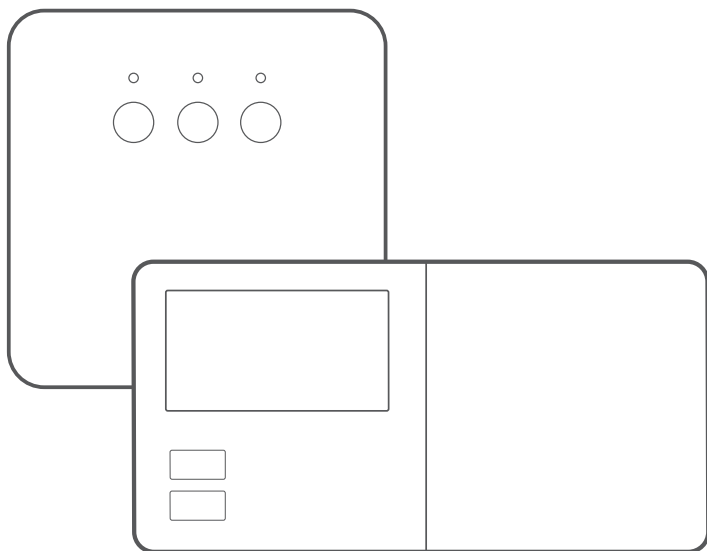

EN

OWNER'S MANUAL



www.auraton.pl

Thank you for purchasing this modern, advanced, microprocessor-based temperature regulator:

AURATON R30 RT



8 independently settable temperatures for day and night time

The AURATON R30 RT temperature regulators allow for setting up to eight independent temperatures for day and night time with the resolution of one minute. The user can select time ranges for various temperatures depending on his or her requirements.

16A

Operation under loads up to 16A/10A

The AURATON RT receiver is equipped with a relay capable of operating with the load up to 16 A. Its low-sparking technique of switching mains voltage contributes to the low wear of relay contacts.



Calibration of temperature indications (offset)

Allows for correcting temperature measurements within the range of $\pm 3^{\circ}\text{C}$.



Interference-free communication between devices

The transmitter and the receiver of the AURATON R30 RT set communicate using the frequency of 868 MHz. Very short, encrypted data transmission packets (approx. 0.004 s) ensure very efficient and interference-free operation of the device.



Backlit LCD display

The backlit LCD display allows for supervising operation of the device even in a poorly lighted room. (Features 3 selectable backlight colours)

Optional elements of the system



AURATON H-1

Window handle (sold separately)

A window handle, equipped with a position sensor and a transmitter, is an optional element of the system. This way the handle provides information about the state of the window. The handle also differentiates between 4 window positions: opened, closed, pivoted and trickle ventilated (micro-ventilation). The handle transmits information to the RT receiver that controls the relay, e.g. switching off a heater in the event of opening the window or lowering the temperature down to 3°C to conserve energy. One RT receiver operates with max 25 handles.



AURATON T-2

Thermometer (sold separately)

An optional element of the system allowing for controlling temperature in a room other than that with the AURATON R30 RT regulator.

Description of the AURATON R30 RT temperature regulator

On the right side of the front panel of the regulator you will find a sliding cover. There are buttons under the cover. You can replace batteries by removing the cover completely.

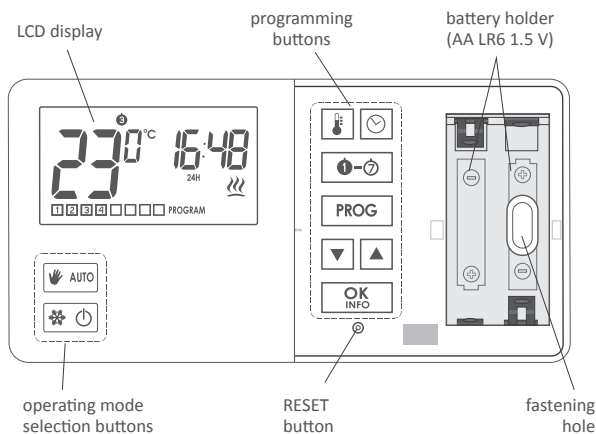

Display

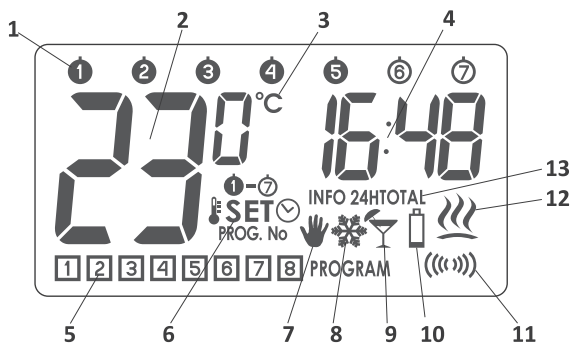

1. Day of week ()

Indicates the current day of week. Every day is assigned a number.

2. Temperature

In the normal mode of operation, the regulator displays the temperature in the room it is installed in.

3. Temperature unit

Informs that the temperature is displayed in degrees Celsius (°C).

4. Clock

Time is displayed in the 24-hour format.

5. Program number ()

Shows the total number of user-defined programs saved on the regulator.

6. Setting mode indicator (SET)

The word **SET** appears when the user changes one of the following settings of the thermostat:

 **SET** - temperature

SET  - time

 **SET** - day of week

SET
PROG. No - program

7. Manual control indicator ()

Appears when leaving the program-based mode of operation.

8. Anti-freeze mode indicator ()

Indicates that the regulator operates in the anti-freeze mode

9. Vacation mode indicator ()

Indicates that the regulator operates in the vacation mode.

(See chapters: “Temperature programming” and “Vacation mode”).

10. Low battery ()

This indicator will be visible when the battery voltage drops below the minimal allowable level. In such an event, replace the batteries as soon as possible.

NOTE: In order to preserve the parameters programmed, duration of the replacement operation must not to exceed 30 seconds.

11. Transmission symbol ()

Indicates ongoing communication with the RT receiver.

12. Relay activation indicator ()

A segment informing about the operating state of the controlled device. Visible when the controlled device is turned on (e.g. a heater).

13. Information about operation of the regulator (INFO)

INFO - acurrent program settings

INFO 24H - relay operating time during the last 24 hours

INFO TOTAL - total operating time of the relay since the start of the regulator





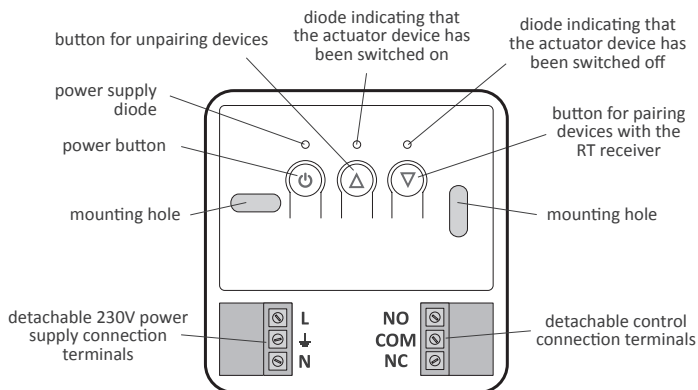

NOTE: “RESET” causes both operating time counters to be set to zero (INFO 24H, INFO TOTAL).

Description of the AURATON RT receiver

The AURATON RT receiver works with the wireless AURATON R30 RT controller. The receiver is installed near the heating or air conditioning device and may work with the load of **16A/10A**.



Legend – description of LED signalling

-  ● □ FF **The LED light's green** – the output device is off (the contacts COM and NC are closed).
-  ● □ N **The LED light's red** – the output device is on (the contacts COM and NO are closed).
-  ◐ IN **The LED flashes green** – the RT receiver awaits the device to be paired (*chapter: "Pairing the AURATON R30 RT wireless regulator and the RT receiver"*).
-  ◐ OUT **The LED flashes red** – the RT receiver awaits the device to be deregistered (*chapter: "Deregistering the regulator from the RT receiver"*).
-  **ALARM RESET** **The LED flashes alternating red and green:**
 - ALARM** - the RT receiver has lost connection with one of the paired devices (*chapter "Special situations"*).
 - RESET** - receiver deregisters all previously paired devices (*chapter "Deregistering all devices paired with the RT receiver"*).
-  **Green power supply diode** – the RT receiver is switched on.

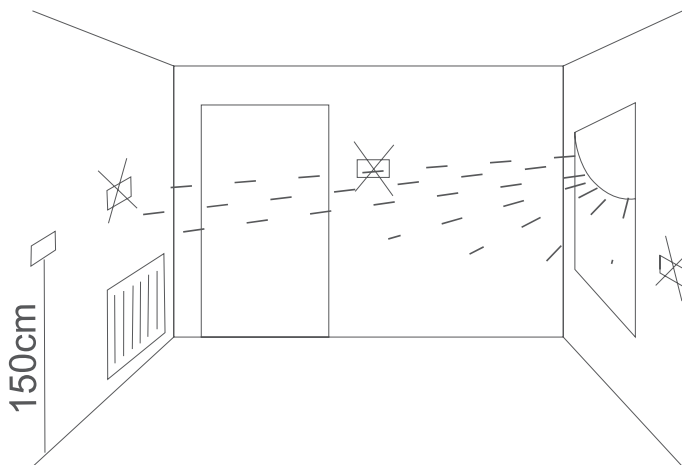

Selecting the proper location for temperature regulator

Proper operation of the regulator is greatly affected by its location. Installing it in a place with no air circulation or exposed to direct sunlight causes improper regulation of temperature. In order to ensure proper operation, the regulator must be installed on an interior wall of a building (partition wall). A place should be selected that is occupied most frequently, providing undisturbed circulation of air. Avoid heat radiating devices (television set, heater, refrigerator etc.) or places exposed to direct sunlight. In order to avoid vibration, do not place the regulator in close vicinity of doors.

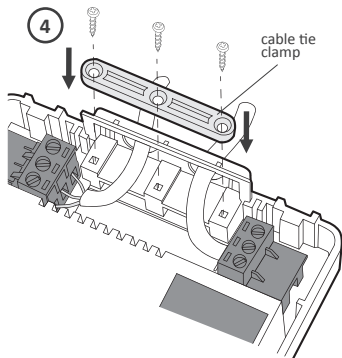
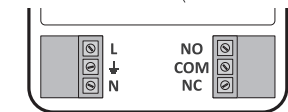
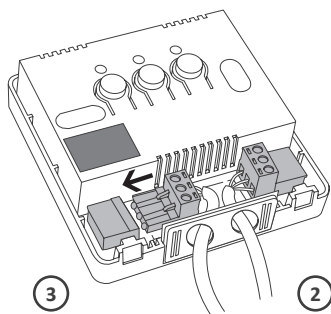
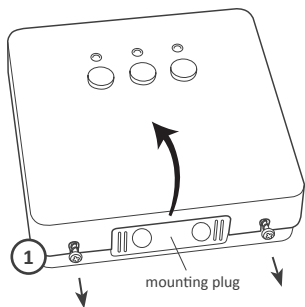

Installation of the AURATON RT receiver



-  **CAUTION!** The cables delivered in a set together with the controller are suitable for maximum loads equal to 2.5 A.
-  If devices with higher power are connected, the cables should be replaced with ones of appropriate cross-sections.

NOTE: When installing an AURATON RT receiver, make sure that the power supply is switched off. The receiver should be installed by a professional.

NOTE: In the permanent system of the building there must be a switch and an overcurrent protection.

NOTE: In order to facilitate installation, the terminals are fitted with extendable clamps. Before cable connections are made, they can be disconnected from the controllers. The cables may be routed from the bottom of the receiver by breaking out holes in the mounting cover or from the back of the receiver if the cables are extended from the wall. In order to connect the cables from the back, the cover must be broken out.

1. Take off the cover of the front part of the AURATON RT receiver by unscrewing the screws half way out.
2. Connect the heating device to the terminals of the control connection of the AURATON RT receiver. Follow the service instruction of the heating device. The COM (common) and NO (normally opened) terminals are used the most often.
3. Connect the power supply cables to the terminals of the power supply connection of the AURATON RT receiver, in observance of safety rules.
4. After the cables are connected, they must be fixed with the "cable fastening holder" and the covers must be screwed back to the AURATON RT receiver.

Fastening the temperature regulator to the wall

1. Drill two holes 6 mm in diameter in the wall (use the template attached to the manual to mark the spacing between these holes).
2. Insert plastic wall plugs (included in the kit).
3. Screw in the left screw with a 3 mm clearance.
4. Put the regulator over the screw head and slide it to the left (pay attention to the key-hole in the rear wall of the regulator).
5. Screw in the right screw, making sure it holds the regulator securely.

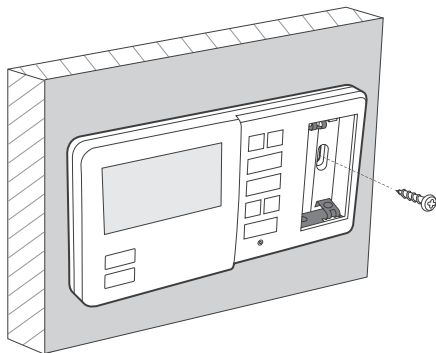
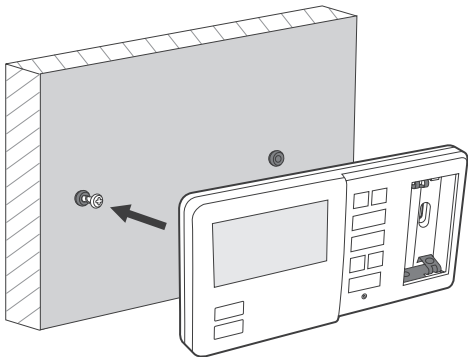

NOTE: If the wall is wooden, there is no need to use wall plugs. In such a case, drill two holes 2.7 mm in diameter instead of 6 mm, and screw the screws directly into the wood.

Fastening the AURATON RT receiver to a wall

In order to fasten the AURATON RT receiver on a wall:

1. Take off the covers from the front part of the controller (see chapter "Installation of the AURATON RT receiver").
2. Mark the location of the holes for the fastening screws on the wall.
3. In the marked locations, drill holes with diameters appropriate for the diameters of the enclosed wall plugs (5 mm).
4. Put the wall plugs in the drilled holes.
5. Fasten the AURATON RT receiver to the wall using screws so that the receiver is well fastened.

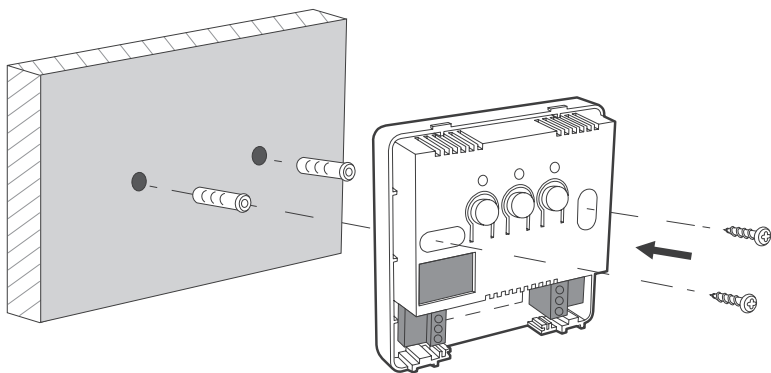

NOTE: If the wall is wooden, there is no need to use wall plugs. In such a case, drill two holes 2.7 mm in diameter instead of 5 mm, and screw the screws directly into the wood.

NOTE: The RT receiver cannot be placed in metal containers (e.g. an assembly box, a metal enclosure of a heater) in order to not to interfere with its operation.



Pairing of the wireless AURATON R30 RT controller with the AURATON RT receiver

After the receiver is connected to the network, the receiver must be switched on by quickly pressing the power button (). If the device is switched on, the green power supply diode becomes illuminated and a single sound signal is emitted. In order to switch off the receiver, e.g. outside of the heating season, press the power button and hold it for 3 seconds until a double sound signal is audible and the green power supply diode is switched off and, consequently, the heating device is switched off.

NOTE: If the wireless controller AURATON R30 RT is sold together with the AURATON RT receiver, the two devices are factory-paired. Devices purchased separately must be paired.

1. Pairing of the AURATON R30 RT controller with the AURATON RT receiver is initiated by pressing the right pairing button () – a single sound signal is emitted - on the AURATON RT receiver and by holding it pressed for at least 3 s until the LED diode starts blinking with green light (double sound signal) – then the button must be released.

The AURATON RT receiver waits for pairing for 120 seconds. After this period, it automatically returns to normal operation.

2. On the AURATON R30 RT, the  button must be pressed for 5 seconds until the transmission symbol () is illuminated on the display. Release the button – the controller emits the pairing signal for 5 seconds.
3. Successful end of pairing is indicated by the LED diode on the AURATON RT receiver no longer blinking green, emission of a single sound signal, and the receiver switching to normal operation.

*In the event of a pairing error, steps 1 and 2 must be repeated. If more errors occur, all devices must be unpaired by **RESETTING** the AURATON RT receiver (see „RESET - Unpairing all devices paired with the AURATON RT receiver“) and then an attempt must be made to pair the devices again.*

NOTE: Only 1 temperature controller may be paired with one receiver.

Unpairing of the controller and the RT receiver



1. Unpairing of the AURATON R30 RT controller from the AURATON RT receiver is initiated by pressing the left unpairing button () on the receiver and holding it for at least 3 seconds until the LED diode starts blinking red - then the button must be released. The sound signal works in the same way as during pairing, i.e. when a button is pressed, a short sound is emitted and another short sound signal after 3 seconds.

The receiver waits for pairing for 120 seconds. After this period, it automatically returns to normal operation.

2. On the AURATON R30 RT, the **PROG** button must be pressed for 5 seconds until the transmission symbol () is illuminated on the display. Release the button.
3. Successful unpairing is indicated by the LED diode on the AURATON RT receiver no longer blinking red, emission of a single sound signal, and the receiver switching to normal operation.

In the event of an unpairing error, steps 1 and 2 must be repeated. If more errors occur, all devices must be unpaired (see „RESET – Unpairing all devices paired with the AURATON RT receiver“).

RESET – Unpairing all devices paired with the AURATON RT receiver

In order to unpair all devices paired with the AURATON RT receiver, simultaneously press and hold both the pairing and the unpairing button ( and ) for at least 5 seconds, until the LED diode starts blinking green and red alternately. Then release both buttons. Sound signal: when the button is pressed, a short sound signal is emitted, followed by another short signal 5 seconds later.

Successful completion of unpairing of all devices is signaled after about 2 seconds by the diode color changing to green and then switching off for a short time.

NOTE: *If the power supply of the AURATON RT receiver is switched off and then switched on after the RESET, the receiver automatically goes into the “pairing” mode for 120 seconds. A newly purchased (separately from the controller) AURATON RT receiver acts in the same way if it has no factory-paired devices.*

Signaling of operation and receipt of data packets

Each reception of radio transmission from a paired device is indicated by the AURATON RT receiver by a momentary change of the color of the LED diodes. After the relay becomes activated, the LED diode is red and after it is switched off – it is green.

NOTE: When any button is pressed, a short sound signal is emitted.

Starting-up the regulator for the first time

After the proper placement of batteries in the battery holder, all segments of the LCD display are displayed (display test) for one second; during the next second, the software version number is displayed.

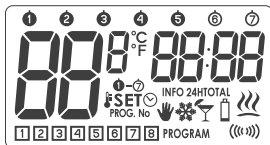

Following that, the regulator enters time setting mode; the hour field flashes, prompting for setting it.

Using the and buttons, set the desired hour value and confirm the setting with the button.

The regulator switches to setting minutes.

Using the and buttons, set the desired minute value and confirm the setting with the button.



In the upper part of the display, the day of the week symbol starts flashing.

Using the and buttons, set the desired day of the week and confirm the setting with the button.

The regulator enters its normal mode of operation.



- | | |
|-------------|------------|
| – Monday | – Saturday |
| – Tuesday | – Sunday |
| – Wednesday | |
| – Thursday | |
| – Friday | |

NOTE:











If no button is pressed in 60 seconds when setting the hour value for the first time, the regulator will automatically assume default time of 12:00 and Monday () as the day of week.

NOTE:

When programming any other functions, failing to press any buttons in 10 seconds is equivalent to pressing the button.

Setting the clock





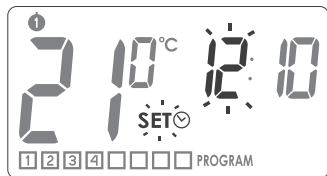

In order to set the clock:

1. Press the  button until the **SET**  icon is displayed, informing that the regulator has entered the time setting mode, and the hour field starts flashing.
2. Using the  and  buttons, set the desired hour value.
3. Then press the  or  button again, and when the minute field starts flashing, set () () the desired minute value.
4. Confirm the setting with the  or  button.



Setting the day of week ① ... ⑦

In order to set the day of week:

1. Press and hold the  button until the **SET**  icon is displayed, informing that the regulator has entered the day of week setting mode and one of the digits representing days of week starts flashing.
2. Using the  and  buttons, set the desired day of week.
3. Confirm the setting with the  or  button.

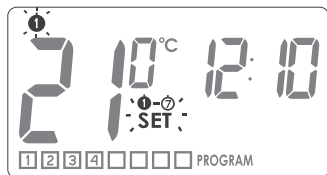

LO / HI temperature

- If the surrounding temperature is lower than 5 °C, the display shows "LO".
- If the surrounding temperature is higher than 35 °C, the display shows "HI".



PROGRAMMING

The memory of the regulator allows for saving up to eight programs for weekdays, eight programs for Saturday and the same for Sunday.

This allows for exceptionally precise planning of temperature in the building depending on the time of day

Factory programs *(for modification)*

① ② ③ ④ ⑤ Weekdays			⑥ Saturday			⑦ Sunday		
Prog.	Start time	Temperature	Prog.	Start time	Temperature	Prog.	Start time	Temperature
①	6:00	21°C	①	6:00	21°C	①	6:00	21°C
②	8:30	20°C	②	23:00	19°C	②	23:00	19°C
③	15:00	21°C						
④	23:00	19°C						

In order to start programming:

Press and hold the **PROG** button until the **SET** PROG. No flashing icon is displayed.

1. Selecting a program



Using the **▼** and **▲** buttons, select the desired program number **①-⑧** to which you will assign the following parameters:

- **temperature** setpoint,
- **day of week** it applies to,
- starting **time**

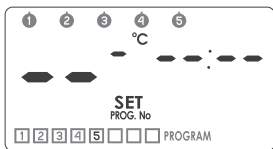
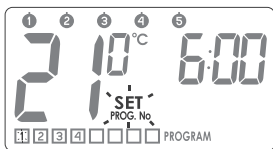

Dashes are displayed on positions corresponding to temperature and time until the program is set.



2. Assigning a day to the program

Press the  button to select days to be assigned to the program. A segment with days of week will start flashing in the top part of the display. Using the   buttons, you can assign:



-      – for week days
-  – for Saturday
-  – for Sunday

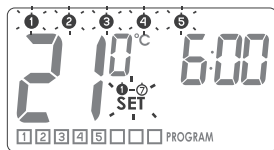

Confirm selection by pressing the  button. The  icon and the number of currently edited program will start flashing on the display



3. Assigning temperature to the program



Press the  button to assign temperature to the program.

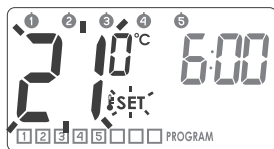

The  icon will start flashing, prompting for setting the temperature. Set the desired temperature, using the   buttons.



Confirm the setting by pressing the  button. The  icon and the number of currently edited program will start flashing on the display again.



4. Assigning starting time to the program

Press the  button. The  icon will start flashing, prompting for setting the time.

Set the desired starting time for the program, using the   buttons.

Confirm the setting by pressing the  button. The  icon and the number of currently edited program will start flashing on the display again.

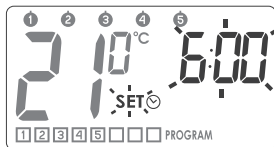

5. Repeat the procedure for consecutive programs.

The whole is confirmed with the  button.

DELETING A PROGRAM:

To delete a selected program, set “dashes” in the temperature field.



NOTE:







1. Programs with the same program numbers, but assigned to other days of week can have completely different settings. *E.g.: program 1 on Saturday can start at 08:00, and program 1 on Sunday can start at 10:00.*
2. Days from ① to ⑤ (from Monday to Friday) have the same programs.
3. On the same day of week, **the next program should start at least a minute after the start of the previous one.** Otherwise the regulator will renumber the programs in order to preserve the chronology of temperature setpoints
4. For the selected day of week, the period of temperature programming cannot exceed 24 hours – the last program can start no later than a minute after the first one.
5. When all programs are inactive, the regulator remains turned off.

Programming the manual 🖐️, vacation 🍷 and anti-freezing temperature ❄️

The AURATON R30 RT regulator allows for setting three kinds of temperature:

- manual temperature (🖐️) – within the range from 5°C to 30°C
- vacation temperature (🍷) – within the range from 5°C to 30°C
- anti-freeze temperature (❄️) – within the range from 4°C to 10°C

To set one of the above mentioned temperatures:

1. Press the  button and wait until flashing  icon is displayed with the symbol of the currently edited kind of temperature.
2. Pressing the  button again will toggle the currently edited kind of temperature.
3. Set the desired temperature value in the currently edited kind of temperature, using the   buttons.
4. After setting all temperature kinds, confirm the setting by pressing the  button.









Factory setting:

 manual	20°C
 vacation	16°C
 anti-freeze	7°C

Manual control

When, for any reason, you would like to suspend execution of the program for a certain period of time, the temperature can be set manually for a specified time. In such a case you have to:

1. Press the  **AUTO** button. This will cause the **SET** and  icons to appear flashing on the display. The temperature field will become editable, with the previously programmed value set as default. Use the   buttons to edit the value, and the  button to confirm settings
2. To leave the manual control mode, press the  **AUTO**.









Vacation mode

Should there be a need for suspending execution of the programs for a prolonged time, the **vacation mode** can be used.



When this option is active, the regulator executes only the “vacation temperature” (see chapter: “Temperature programming”).

Maximal duration of operation in vacation mode is 6 days, 23 hours and 59 minutes.

In order to enter the vacation mode:

1. Press the  **AUTO** button and hold it for 3 seconds. This will cause flashing of the **SET** and  icons as well as the field time.
2. Using the  and  buttons, set the time when the vacation mode should end.
3. By pressing the  button you can set the day when the vacation mode should end. The  icon will start flashing on the display. Using the  and  buttons, set the day when the vacation mode should end.
4. Całość zatwierdzamy przyciskiem .







The “” symbol will be displayed on the screen while the vacation mode is active. You can leave the vacation mode earlier by pressing the  **AUTO** button

Anti-freeze mode

The AURATON R30 RT regulator is equipped with a setpoint for the anti-freeze temperature. This setpoint can be set within the range from 4 to 10°C. (Factory set at 7°C)

The anti-freeze mode is used during a prolonged period of absence or outside the heating season and is designed to prevent water in the heating system from freezing

1. To enter the anti-freeze mode, press the  button. The “” icon will appear on the display.
2. To leave the anti-freeze mode press the  or  button.

Switching off the receiver for a period of time

Pressing the  button and holding it for 5 seconds causes switching off the thermostat relay, setting the temperature in the receiver to 4 °C and putting out all elements on the display except for current temperature, time and day of week.

To restore normal operation of all functions of the regulator, press the  button.

Viewing the currently active program

Pressing the  button in the normal operation mode causes the **INFO** segment and all the parameters of the currently executed program (day of week, temperature and ending time) to flash for 10 seconds on the display.

To restore the regulator back to normal operation, press the  button again.

Relay operating time counter

Pressing the  button and holding it for 3 seconds activates the **INFO 24H** function that counts the relay operating time during the last 24 hours.

Pressing the  button again causes the **INFO TOTAL** segment to appear, corresponding to the function of counting the accumulated number of days of relay operation

To restore the regulator back to normal operation, press the  button again.

NOTE: To reset the total counter of days of relay operation to zero, press the  button and hold it for 5 seconds, while in the **INFO TOTAL** mode.

NOTE: “RESET” causes both operating time counters to be set to zero.

Configuration settings: backlight colour, hysteresis, delay, offset, clock calibration

Configuration settings are presented for changing in the following order

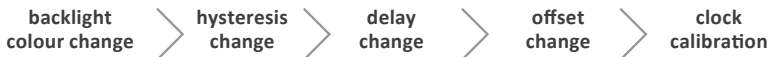

To enter the configuration settings change mode press the buttons simultaneously and hold them for 5 seconds until the display backlight starts flashing.

1. BACKLIGHT COLOUR CHANGE

Flashing backlight indicates that you can change the backlight colour with the buttons. Confirm the setting by pressing the button. The regulator will proceed to change the next parameter.

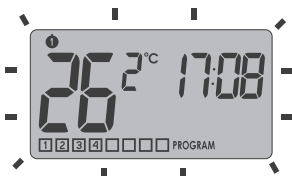

2. HYSTERESIS CHANGE

Hysteresis is designed to prevent switching the controlled device on and off too frequently due to minute fluctuations of temperature.

E.g. for the HI 2 hysteresis, when the temperature is set to 20 °C, the boiler will be switched on at 19.8 °C, and switched off at 20.2 °C. For the HI 4 hysteresis, when the temperature is set to 20 °C, the boiler will be switched on at 19.6 °C, and switched off at 20.4 °C

The hysteresis change mode is signalled by flashing text “HI”. You can change hysteresis settings with the buttons.

HI 2 – $\pm 0,2^{\circ}\text{C}$ (factory setting)

HI 4 – $\pm 0,4^{\circ}\text{C}$

HI P – PWM operation mode (see chapter “PWM operation mode”).

Confirm the setting by pressing the button. The regulator will proceed to change the next parameter.

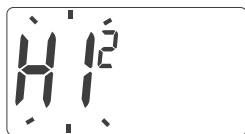

3. OFFSET CHANGE

Offset allows for calibrating temperature indications within the tolerance of $\pm 3^{\circ}\text{C}$.

E.g. the temperature regulator indicates that the room temperature is 23°C, whereas a regular mercurial thermometer placed alongside indicates 24°C. Changing offset by +1 degree makes the regulator indicate the same temperature as the mercurial one.

The offset change mode is signalled by flashing text **OFFS**. You can set the desired value within the range from 3.0 to 3.0 (factory setting is 0.0).

Confirm the setting by pressing the button. The regulator will resume normal mode of operation.



4. CLOCK CALIBRATION

This function is used for correcting the clock in case of deviations. When poor operation of the clock is observed during a week, determine the value of incorrect displays. This value, expressed in seconds, should be entered into the controller.

Example 1:

After one week, the controller indicates time accelerated by 1 minute and 20 seconds ($60+20=80$), in which case the clock should be delayed by setting „C -80”.

Example 2:

After one week, the controller indicates time delayed by 2 minutes ($2\times60=120$), in which case the clock should be accelerated by setting „C 120”.

NOTE: To calibrate the clock properly, specify the number of seconds after a week of operation of the controller (7 days = number of seconds to be added or subtracted, maximum 294 seconds).

NOTE: If no button is pressed for 10 sec. during the change of configuration settings, then the controller will return to normal operation mode.

PWM operation mode (Pulse-Width Modulation)

By changing the settings of the hysteresis (see chapter “Configuration settings”), you can switch on the PWM operation mode.

In this mode, the controller cyclically switches the heating device on so as to minimize the temperature fluctuations. The controller checks the temperature increase times and the temperature decrease times.

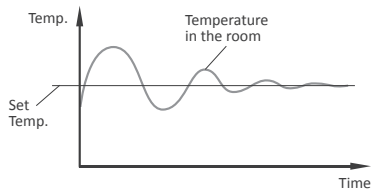

Once these values are known, the controller switches the heating device on and off in cycles that enable keeping the temperature as close as possible to the set value.

NOTE: In the PWM mode, the controller can switch on the heating device even if the temperature in the room is higher than the set temperature. This is due to the PWM algorithm which strives to maintain the set temperature and to anticipate the behavior of the heating system.



Cooperation of the RT receiver with a heating device

Basic configuration of devices

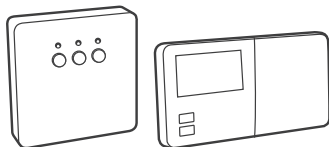

AURATON RT

Receiver connected to the heating device

AURATON R30 RT

Wireless temperature regulator

Additional system devices



AURATON T-2

Wireless thermometer (sold separately)



AURATON H-1

Window handle (sold separately)

A simplified schematic of connecting the AURATON RT receiver with the heating device

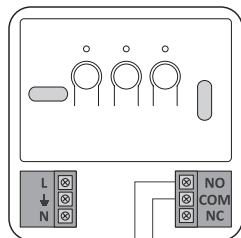
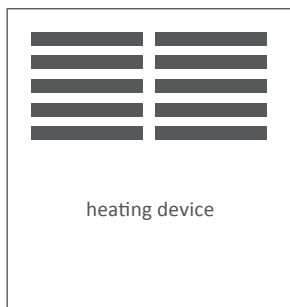
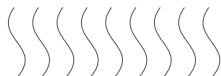

Cooperation of the AURATON RT receiver with the AURATON R30 RT regulator and/or the AURATON T-2 thermometer

The operation of temperature regulation in the receiver is based on the binary algorithm (on/off) using one or two sensor elements.

- The AURATON R30 RT regulator allows for setting and/or monitoring the temperature.
- The AURATON T-2 thermometer provides information about the current temperature only, without the capability of changing it manually.

A) The manual setpoint – pairing the AURATON R30 RT regulator with the RT receiver allows for setting the temperature manually and controlling it in the location of the fastening of the R30 RT regulator.

B) The remote setpoint – if the T-2 thermometer is additionally paired with the RT receiver, the AURATON R30 RT regulator retains the capability of temperature setting, however its control is performed with the paired T-2 thermometer only. This feature allows for regulating the temperature in a room other than the one where the AURATON R30 RT regulator is placed.

An example: you want the temperature in the “children’s room” to be always at 22°C, however you do not want children to be able to change it - in that room, you install the T-2 thermometer, and the AURATON R30 RT regulator in e.g. the kitchen. This way the temperature in the “children’s room” will always be at 22°C regardless of temperature fluctuations in the kitchen.

C) The factory setpoint (20°C) – if the T-2 thermometer is the only device paired with the RT receiver, it is not possible to set the temperature manually, and the RT receiver maintains the factory temperature setpoint of 20°C.

NOTE!

1. The sequence of pairing the AURATON R30 RT regulator and the T-2 thermometer is very important. If you want to maintain the remote setpoint, you must first pair the AURATON R30 RT with the RT receiver, and then the T-2 thermometer. Reversing the pairing sequence will cause automatic deregistering of the previously paired T-2 thermometer and entering the mode of operation described in item A.
2. The RT receiver can operate with one AURATON R30 RT regulator and/or one T-2 thermometer only. Pairing a new regulator causes deregistering the previously paired regulator and the T-2 thermometer. Pairing a new T-2 thermometer causes deregistering the previously paired T-2 thermometer only.
3. The R30 RT regulator and/or the T-2 thermometer can operate with an unlimited number of receivers, e.g. one regulator can simultaneously control two independent heating devices.

Cooperation with the AURATON R30 RT regulator and/or the AURATON T-2 thermometer as well as the AURATON H-1 handles

By default, the AURATON RT receiver does not have any AURATON H-1 handle or AURATON W-1 window position sensor paired, therefore the relay is controlled by the paired AURATON R30 RT regulator and/or the AURATON T-2 thermometer. When at least one H-1 handle is paired with the RT receiver, the relay is controlled in the following manner:

A) The window is closed or trickle-ventilated (micro-ventilation).

When the H-1 window handles is paired with the receiver, and all windows are closed or trickle-ventilated, the relay still maintains the setpoint from the paired AURATON R30 RT regulator and/or the T-2 thermometer.

B) The window is pivoted.

If at least one window is pivoted, the temperature set in the AURATON R30 RT regulator is lowered in AURATON RT receiver down to 3°C. This state will be maintained until closing. This state will last until all windows are closed or trickle-ventilated.

C) The window is opened.

When you open a window equipped with the H-1 handle paired for longer than 30 seconds, the relay in the AURATON RT receiver is switched off, as is the connected heating device. If all the assigned windows are again in a state other than “opened”, the RT receiver returns to normal cooperation with the AURATON R30 RT regulator and/or the T-2 thermometer no earlier than 90 seconds after switching off the relay. The purpose of this delay is to prevent too rapid transitions of the connected heating devices between the ON and OFF states. However, if the temperature in the room drops below 7°C, the relay inside the receiver is switched on regardless of the positions of windows in order to prevent the room from freezing.

D) The signal is lost.

When the RT receiver has lost the signal from the H-1 handle paired (3 consecutive transmissions are lost), it changes the status of this window to “closed”. When the transmission is restored, the H-1 handle is again properly read off by the RT receiver.

RESET of the regulator

Pressing the **RESET button** (Ⓢ) causes the time and day setting to be erased, and the regulator to be restarted.

MASTER RESET of the regulator

The MASTER RESET function restarts the regulator and restores factory settings. This function is invoked by pressing the K and RESET buttons simultaneously.

NOTE: All user-defined programs will be erased!

Special situations

- When 3 consecutive transmissions (after 15 minutes) from the AURATON R30 RT regulator and/or the T-2 thermometer are lost, an error is signalled on the RT receiver (LED flashing continuously red and green). The RT receiver starts executing the ON - OFF cycle memorised during the last 24 hours of operation until the problem is removed.
- When both signals return (from the AURATON R30 RT regulator and the T-2 thermometer), the error is cancelled and the receiver enters its normal mode of operation.
- When only the T-2 thermometer signal returns, the receiver uses the last memorised setpoint value and maintains it while signalling the error.
- When the H-1 handles, the T-2 thermometer and the AURATON R30 RT regulator (the temperature is measured with the T-2 thermometer) are paired with the receiver, then maintaining the work cycle from the last 24 hours occurs only after losing the signal from the T-2 thermometer. When only the signal from the AURATON R30 RT is missing, the RT receiver automatically maintains the last memorised setpoint from the AURATON R30 RT regulator and also signals an error.
- When you have only the H-1 handles and the T-2 thermometer paired with the RT receiver without the AURATON R30 RT regulator, the RT receiver maintains a constant, factory-defined temperature of 20°C. If you pivot any window equipped with the H-1 handle paired with the receiver, a temperature of 17°C is maintained. If you open any window equipped with the H-1 handle paired with the RT receiver, the receiver switches off the heating device, but will switch it back on when the temperature falls below 7°C.

Unique features of AURATON R30 RT

- Switching the relay is synchronised with the wave of the 230 V mains voltage in order to ensure that closing and opening contacts of the relay occurs around the zero-crossing point. This prevents the occurrence of an electric arc, significantly extending the relay service time.
- The AURATON RT receiver is equipped with a unique algorithm for analysing the ON - OFF cycles. The entire heating cycle from the last 24 hours is recorded in the memory of the RT receiver. In the event of losing communication with the AURATON R30 RT regulator and/or the T-2 thermometer, the RT receiver automatically executes the ON - OFF cycle memorised during the last 24 hours. This provides time for restoring transmission (removing interferences) or fixing the R30 RT regulator and/or the T-2 thermometer without a significant deterioration of thermal comfort conditions in the controlled spaces.
- The backlit LCD display with the capability of selecting one of three available colours.
- The run time LCD counter of the AURATON R30 RT transmitter.
- Cooperation with optional devices (the AURATON T-2 thermometer, the AURATON H-1 window handle).

Additional information and notes

- The AURATON R30 RT regulator and/or the T-2 thermometer must be installed at least 1 metre from the RT receiver (too strong a signal from the transmitters can cause interference).
- At least 30 seconds must elapse between switching the relay off and on.
- Data transmission from the AURATON R30 RT regulator to the receiver occurs upon each change of 0.2°C of the surrounding temperature. When the temperature is stable, the regulator sends heart-beat data every 5 minutes (which is signalled with the LED blinking orange on the RT receiver).
- In the event of a power outage, the RT receiver will switch off. When power is restored, the heating device is switched on automatically, and the RT receiver awaits a signal from the paired transmitters (this signal should be received within 5 minutes of restoring power). After receiving the signal, the RT receiver enters the normal mode of operation.
- The RT receiver cannot be placed in metal containers (e.g. an assembly box, a metal enclosure of a heater) in order to not to interfere with its operation.

The AURATON RT receiver connection schematics

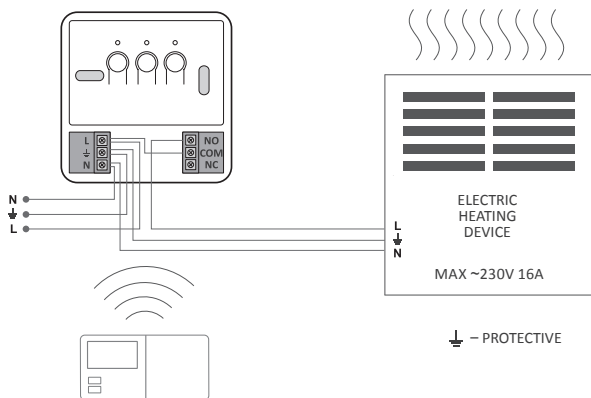
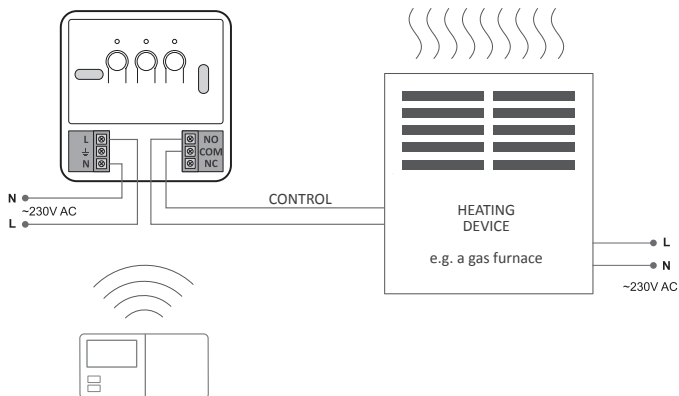

Technical specifications

Working temperature range:	0 – 35°C
Temperature measurement range:	5 – 30°C
Span:	±0,2°C / ±0,4°C / PWM
Dokładność wskazań temperatury:	±1°C
Number of temperature levels:	8 + 3
Number of programs:	8 for week days, 8 for Saturday, 8 for Sunday
Anti-freezing temperature:	4 – 10°C
Operating cycle:	weekly, programmable
Monitoring of operating state:	LED (the RT receiver) / LCD (the regulator)
Maximum load current for relay contacts:	resistive 16 A inductive / capacitive 10 A
AURATON R30 RT power supply:	2 x AA alkaline battery
AURATON RT power supply:	230V AC, 50Hz
AURATON RT radio frequency:	868 MHz
AURATON RT operation range:	in a typical building, with standard construction of walls – approx. 30 m; an open space – up to 300 m

Cleaning and maintenance

- Clean the outside of the device with a dry cloth. Do not use from solvents (such as benzene, thinner or alcohol).
- Do not touch the device with wet hands. It may cause electric shock or serious damage to the device.
- Do not expose the device to excessive smoke or dust.
- Do not touch the screen with a sharp object.
- Avoid contact of the device with liquids or moisture.

Disposing of the devices



The devices are marked with the crossed waste bin symbol. According to European Directive no. 2002/96/EU and the Act concerning used up electric and electronic equipment, such a marking indicates that this equipment may not be placed with other household generated waste.

The user is responsible for delivering the devices to a reception point for used-up electric and electronic equipment.



A template for drilling holes for fastening
the AURATON RT receiver (1:1 scale)



A template for drilling holes for fastening
the AURATON R30 RT regulator
(1:1 scale)

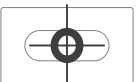



H E A T U N D E R C O N T R O L



www.auraton.pl

ver. 20190218