

AURATON

3021 RT
3021 DS
3021 P
3021

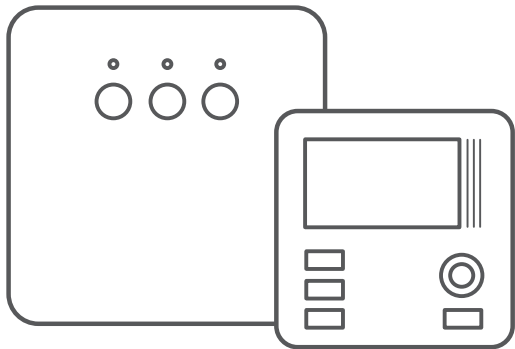

EN

OWNER'S MANUAL

CE

Thank you for purchasing the latest temperature controller based on an advanced microprocessor.

AURATON 3021 / 3021 P / 3021 RT / 3021 DS



3 independent temperature settings

Day, night, anti-freeze.



9 independent temperature programs

Including 6-user defined ones.

LCD

Backlit LCD display

Backlit LCD display to control the device in areas with poor lighting.

Temperature controller explained

On the front of the enclosure, there are four function keys, a backlit LCD display and a temperature control knob with the **OK** button.

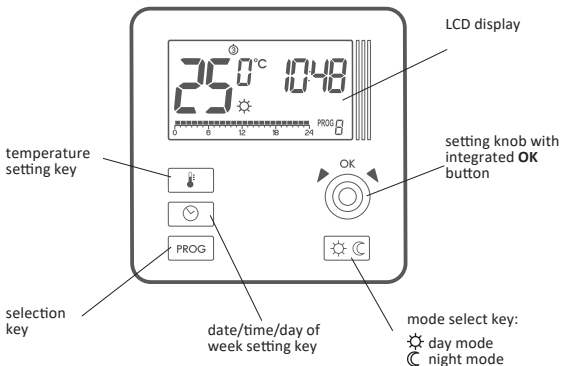

Display

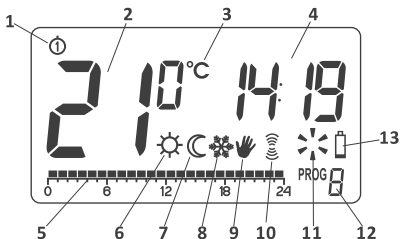

- Day of week (①...⦿)** – Indicates the current day of the week. Each day has a number assigned.
- Temperature** – In normal operating mode, the controller displays the temperature of the room it is installed in.
- Temperature unit** – Indicates temperature displayed in centigrade (°C).
- Clock** – Time displayed in 24-hour mode.
- Timeline** – Program progress indicator. Line divided to 24 sections, each corresponding to one hour. Indicates program execution method. (see: „Timeline”).
- Day mode indicator (☼)**
Indicates that the controller is in the day mode.
(see: „Temperature programming”)

7. Night mode indicator (☾)

Indicates that the controller is in the night mode.
(see: „Temperature programming“)

8. Anti-freeze mode indicator (❄)

Indicates that the controller is in the anti-freeze mode.
(see: „Anti-freeze mode“)

9. Manual control indicator (✋)

Appears if the programmed mode is switched off.
(see: „Manual control mode“)

10. Transmission symbol (📶) – AURATON 3021R only.

Indicates ongoing communication with the RT receiver.

11. Controller power on indicator (⚡)

Indicates the operating status. Visible when the controlled device is started.

12. Program number

Indicates the number of program currently executed.
(see: „Factory programs“ and „Weekly programming“)

13. Battery exhausted (🔋)

Displayed when the battery voltage drops below the allowed limit. Replace the battery as soon as possible.





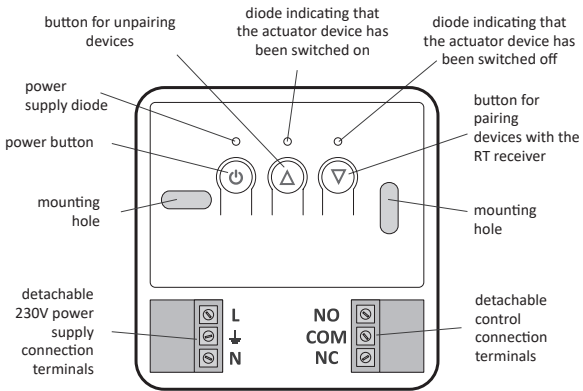

NOTE: To save the parameters programmed, the battery exchange operation should not last longer than 30 seconds.

Description of the RT receiver

The AURATON RT receiver cooperates with the AURATON 3021R wireless receiver. The receiver is installed on the heating or air conditioning device and can operate under the load of **16A/10A**.



Legend – description of LED signalling

-  ● □ OFF **The LED light's green** – the output device is off
(the contacts COM and NC are closed).
-  ● □ ON **The LED light's red** – the output device is on
(the contacts COM and NO are closed).
-  ● IN **The LED flashes green** – the RT receiver awaits
the device to be paired
(chapter: „Pairing the wireless regulator and the RT
receiver“).
-  ● OUT **The LED flashes red** – the RT receiver awaits
the device to be deregistered
(chapter: „Deregistering the regulator from the ceiver“).
-  **ALARM**
RESET **The LED flashes alternating red and green:**
ALARM – the RT receiver has lost connection with
one of the paired devices (chapter „Special situations“).
RESET – receiver deregisters all previously paired
devices (chapter „Deregistering all devices paired
with the RT receiver“).
-  **Green power supply diode** – the RT receiver
is switched on.

Installation of the AURATON RT receiver



CAUTION!

The cables delivered in a set together with the controller are suitable for maximum loads equal to 2.5 A.



If devices with higher power are connected, the cables should be replaced with ones of appropriate cross-sections.

NOTE: When installing an AURATON RT receiver, make sure that the power supply is switched off. The receiver should be installed by a professional.

NOTE: In the permanent system of the building there must be a switch and an overcurrent protection.

NOTE: In order to facilitate installation, the terminals are fitted with extendable clamps. Before cable connections are made, they can be disconnected from the controllers. The cables may be routed from the bottom of the receiver by breaking out holes in the mounting cover or from the back of the receiver if the cables are extended from the wall. In order to connect the cables from the back, the cover must be broken out.

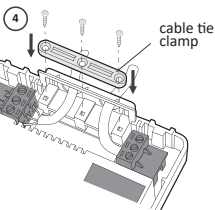
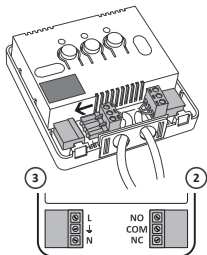
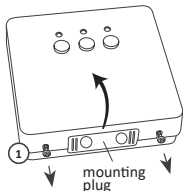

1. Take off the cover of the front part of the AURATON RT receiver by unscrewing the screws half way out.
2. Connect the heating device to the terminals of the control connection of the AURATON RT receiver. Follow the service instruction of the heating device. The COM (common) and NO (normally opened) terminals are used the most often.
3. Connect the power supply cables to the terminals of the power supply connection of the AURATON RT receiver, in observance of safety rules.
4. After the cables are connected, they must be fixed with the “cable fastening holder” and the covers must be screwed back to the AURATON RT receiver.

Fastening the AURATON RT receiver to a wall

In order to fasten the AURATON RT receiver on a wall:

1. Take off the covers from the front part of the controller (see chapter "Installation of the AURATON RT receiver").
2. Mark the location of the holes for the fastening screws on the wall.
3. In the marked locations, drill holes with diameters appropriate for the diameters of the enclosed wall plugs (5 mm).
4. Put the wall plugs in the drilled holes.
5. Fasten the AURATON RT receiver to the wall using screws so that the receiver is well fastened.

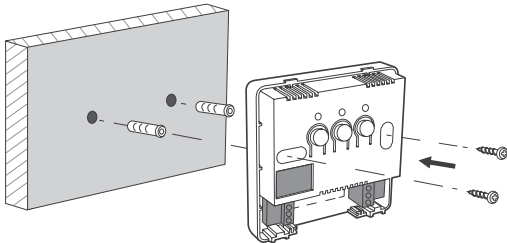

Note: If the wall is wooden, there is no need to use wall plugs. In such a case, drill two holes 2.7 mm in diameter instead of 5 mm, and screw the screws directly into the wood.

Selecting proper location for temperature controller

Controller location largely affects its proper operation. When located in a place without air circulation or exposed to direct sunlight, the controller may not control the temperature properly. The controller should be located on an internal wall of a building (partition wall) in a place with free air circulation. Avoid locations near sources of heat (TV set, heater, refrigerator) or places exposed to direct sunlight. Location near doors and the resultant vibration may cause the controller to function improperly.

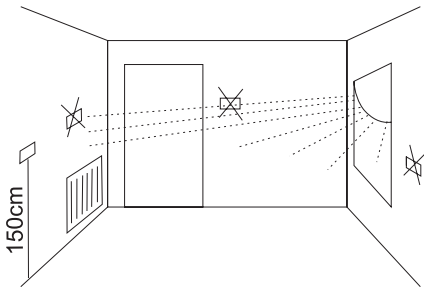

Wiring your AURATON 3021

To connect the wiring, remove the enclosure as described below:

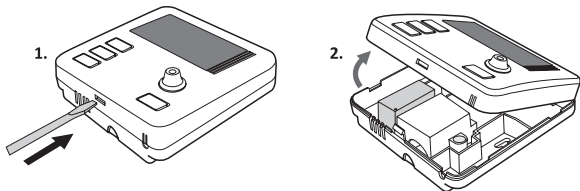

Wiring terminals are located in the controller back wall, under the plastic cover.

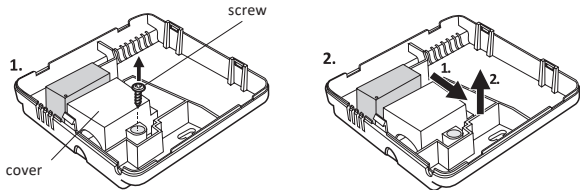

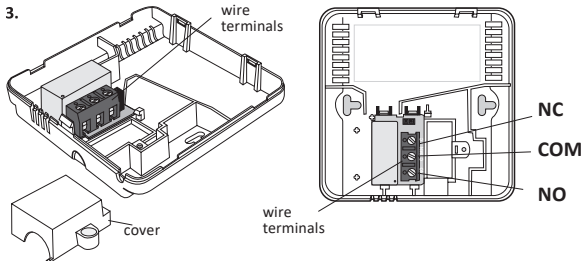

It is a typical bistable relay. The NC terminal is not used in most cases.

NOTE: Replace the plastic cover after wiring.

Battery installation / replacement

The battery socket is located inside the controller, at the front of the enclosure. To install the batteries, remove the controller enclosure as described in the “*Wiring your AURATON 3021*” section.

NOTE: We recommend using alkaline batteries to supply AURATON controllers. Rechargeable batteries should not be used because their rated voltage is too low.

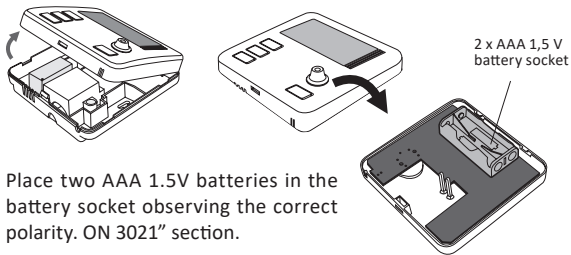

Place two AAA 1.5V batteries in the battery socket observing the correct polarity. ON 3021" section.

Fixing the controller to the wall

To fix the **AURATON 3021** controller to the wall:

1. Remove the enclosure (as described in the "*Wiring your AURATON 3021*" section).
2. Drill 2 holes diameter 6 mm in the wall (use the back of the controller enclosure to set the right spacing of the holes).

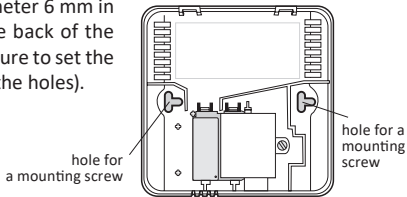

3. Place plastic plugs in the drilled holes.
4. Screw the back of the controller enclosure to the wall with the two screws provided.
5. Replace the controller enclosure.

NOTE: No expansion bolts are needed for wooden walls. Just drill holes diameter 2.7 mm (instead of 6 mm) and screw the screws directly into the wood.

Replacing the enclosure 3021: CAUTION

While replacing the front part of the enclosure on the back one, pay attention to the pin connector that controls the relay.

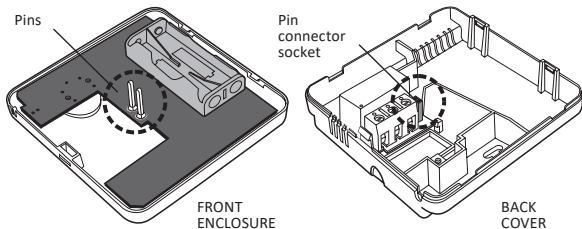

While reassembling ensure that the pins engage with the pin connector socket.

Pairing of the wireless AURATON 3021 RT controller with the AURATON RT receiver

After the receiver is connected to the network, the receiver must be switched on by quickly pressing the power button (). If the device is switched on, the green power supply diode becomes illuminated and a single sound signal is emitted. In order to switch off the receiver, e.g. outside of the heating season, press the power button and hold it for 3 seconds until a double sound signal is audible and the green power supply diode is switched off and, consequently, the heating device is switched off.

NOTE: If the wireless controller AURATON 3021 RT is sold together with the AURATON RT receiver, the two devices are factory-paired. Devices purchased separately must be paired.

1. Pairing of the AURATON 3021 RT controller with the AURATON RT receiver is initiated by pressing the right pairing button () – a single sound signal is emitted – on the AURATON RT receiver and by holding it pressed for at least 3 s until the LED diode starts blinking with green light (double sound signal) – then the button must be released.

The AURATON RT receiver waits for pairing for 120 seconds.

After this period, it automatically returns to normal operation.

2. On the AURATON 2031 RT, the **PROG** button must be pressed for 5 seconds until the transmission symbol () is illuminated on the display. Release the button – the controller emits the pairing signal for 5 seconds.
3. Successful end of pairing is indicated by the LED diode on the AURATON RT receiver no longer blinking green, emission of a single sound signal, and the receiver switching to normal operation.

In the event of a pairing error, steps 1 and 2 must be repeated. If more errors occur, all devices must be unpaired by RESETTING the AURATON RT receiver (see „RESET – Unpairing all devices paired with the AURATON RT receiver“) and then an attempt must be made to pair the devices again.

NOTE: Only 1 temperature controller may be paired with one receiver.

Signaling of operation and receipt of data packets



Each reception of radio transmission from a paired device is indicated by the AURATON RT receiver by a momentary change of the color of the LED diodes. After the relay becomes activated, the LED diode is red and after it is switched off – it is green.

NOTE: When any button is pressed, a short sound signal is emitted.

Unpairing of the controller and the RT receiver

1. Unpairing of the AURATON 3021 RT controller from the AURATON RT receiver is initiated by pressing the left unpairing button () on the receiver and holding it for at least 3 seconds until the LED diode starts blinking red - then the button must be released. The sound signal works in the same way as during pairing, i.e. when a button is pressed, a short sound is emitted and another short sound signal after 3 seconds.

The AURATON RT receiver waits for deregistering for 120 seconds. After that time, it automatically returns back to normal operation.

2. On the AURATON 3021 RT, the  button must be pressed for 5 seconds until the transmission symbol () is illuminated on the display. Release the button.
3. Successful unpairing is indicated by the LED diode on the AURATON RT receiver no longer blinking red, emission of a single sound signal, and the receiver switching to normal operation.

In the event of an unpairing error, steps 1 and 2 must be repeated. If more errors occur, all devices must be unpaired (see „RESET – Unpairing all devices paired with the AURATON RT receiver“).

RESET – Unpairing all devices paired with the AURATON RT receiver

In order to unpair all devices paired with the AURATON RT receiver, simultaneously press and hold both the pairing and the unpairing button (▽ and △) for at least 5 seconds, until the LED diode starts blinking green and red alternately. Then release both buttons. Sound signal: when the button is pressed, a short sound signal is emitted, followed by another short signal 5 seconds later.

Successful completion of unpairing of all devices is signaled after about 2 seconds by the diode color changing to green and then switching off for a short time.

NOTE: *If the power supply of the AURATON RT receiver is switched off and then switched on after the RESET, the receiver automatically goes into the “pairing” mode for 120 seconds. A newly purchased (separately from the controller) AURATON RT receiver acts in the same way if it has no factory-paired devices.*

Starting the controller for the first time

After correct installation of the batteries, the LCD will display, for a second, all segments followed by the firmware version number.

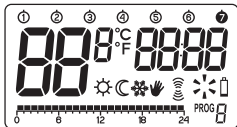

After a while, the controller will automatically switch to time setting mode. A blinking component on the display is in edit mode. Turn the knob clockwise or counter clockwise to set the hour desired and confirm with the **OK** key.



Turn the knob clockwise or counter clockwise to set the correct value for minutes and, again confirm setting with the **OK** key.



In the top left corner a blinking day symbol will appear. Turn the knob clockwise or counter clockwise to set the day desired and confirm with the **OK** key.





NOTE: If no key is pressed for 60 seconds in the initial edit mode, the default time 12:00 and Monday will be automatically set.

NOTE: While programming any other functions, if no key is pressed for 10 seconds, this will be interpreted as pressing the  key.

Setting the clock and day of week

To set the clock:

1. Press the  key.
A segment with time will start blinking on the display.
2. Turn the knob clockwise or counter clockwise to set the hour desired and confirm with the  key.
3. Turn the knob clockwise or counter clockwise to set the correct value for minutes and again confirm with the  key.

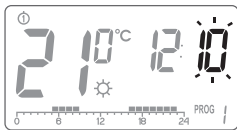
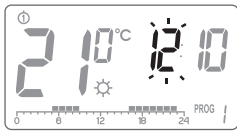

4. In the top left corner a blinking day-symbol will appear. Turn the knob-clockwise or counter clockwise to set the day desired and confirm with the  key.



NOTE: It is also possible to switch settings with the  key.

Default program setting

- **Monday – Friday:**
heaters will operate according to the day temperature (☀) between **05:00 and 8:00** and between **15:00 and 23:00**
- **Saturday – Sunday**
heaters will operate according to the day temperature (☀) between **06:00 and 23:00**
- **default temperature settings:**
 - ☀ day temperature – 21,0°C
 - ☾ night – 19,0°C
 - ❄ anti-freeze temperature – 7,0°C
 - ℱ temperature of the external sensor – 40.0°C

(Auraton 3021 DS only)

Programming day and night temperatures

With AURATON 3021 2 temperatures can be programmed:



- Day temperature (☀) – from 5 to 30°C
- Night temperature (☾) – from 5 to 30°C
- Temperature of the external sensor (F) - from 10 to 55°C

(Auraton 3021 DS only)

To set one of the temperatures:

1. Press the  key.
2. Current temperature setting will be displayed with the symbol:
 - ☀ – **day temperature;**
 - ☾ – **night temperature;**
 - F – **temperature of the external sensor** ((Auraton 3021 DS only)



3. Turn the knob clockwise or counter clockwise to set the temperature desired.
4. Press the  key to switch edit mode between the night and day temperature (☀, ☾).
5. After the setting is complete, press the  key to confirm.

NOTE: The night temperature setting can be equal or lower than the day one. The night temperature cannot be set to the value lower than the day one

PROGRAMMING INTRODUCTION

Timeline

The timeline on the LCD is divided to 24 sections. Each corresponds to 1 hour of the day.

Black rectangles above the timeline indicate day temperature set for the specific hours. Night temperature is set when no rectangles are present.

Example::



The above figure shows that from 6.00 to 23.00, the controller will control the heating equipment to ensure day temperature in the room (☀). From 23.00 to 6.00, the controller will switch to night temperature (☾).

Factory programs

Proper program should be set for every day of the week so that the controller know when to switch between the night and day temperatures. To do so, you can use one of the factory presets available (from 0 to 2):

Program 0 – anti-freeze ❄

Non-editable factory program. Intended for all-day anti-freeze temperature setting.

Program 1 – weekly

Non-editable factory program. Day temperature setting from 5:00 to 8:00 and from 15:00 to 23:00.

Program 2 – weekend

Non-editable factory program. Day temperature setting from 6:00 to 23:00.

Program 3, 4, ..., 8 – user-defined







3 to 9 are user-defined programs. They can be modified and adjusted to your demand.

PPROGRAMMING

Weekly programming

To program the controller, set the day temperature intervals for individual days of the week. At other time, night temperature will be set.

Sample controller setting from Monday to Sunday. Outside the intervals programmed, the night temperature will be se.

Day	Day temperature	
Monday	5:00 – 8:00; 15:00 – 23:00	
Tuesday	5:00 – 8:00; 15:00 – 23:00	
Wednesday	5:00 – 8:00; 15:00 – 23:00	
Thursday	5:00 – 8:00; 15:00 – 23:00	
Friday	5:00 – 8:00; 15:00 – 23:00	
Saturday	8:00 – 23:00	
Sunday	8:00 – 23:00	

PROGRAM SELECTION

To set the program:

1. Press the **PROG** key. Program number segment will start blinking.

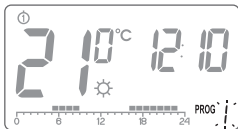

2. Press the  key as many times as required to set the day of the week for the program.

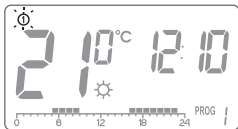

3. Press the **PROG** key several times and select the program number requested. Programs **0-2** are factory-set, programs **3-8** can be edited.

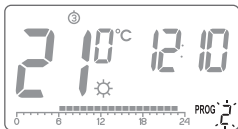

4. Confirm selection pressing the  key.

5. Repeat the procedure for the following days of the week.



MODIFYING USER-DEFINED PROGRAMS (prog. 3...8)

To set the program:

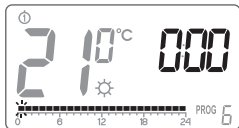
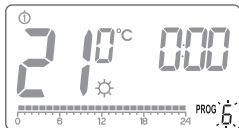
1. Press the **PROG** key. Program number segment will start blinking.
2. Press the  key as many times as required to set the day of the week for the program.
3. Press the **PROG** key several times to select the program number required. Programs **0-2** are factoryset, programs **3-8** can be edited.
4. All (24) black rectangles will appear on the timeline. Each of them symbolises 1 hour. A visible rectangle indicates day temperature set for the given time. If no rectangle is displayed, night temperature is set.



Blinking rectangle indicates the point of the timeline which is modified.

5. Press the  key to select day (rectangle on) or night temperature (no rectangle). Then, select the time interval for the temperature selected with the knob.
6. By pressing the  key and selecting time interval the entire program is modified.
7. Confirm selection with the  key.

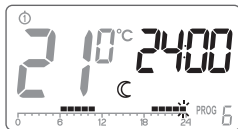
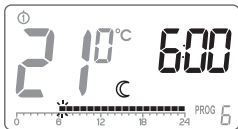





NOTE: Modified program for the individual day can be selected and executed also on a different day of the week.

Manual control

Option 1



If, for some reasons, you would like to suspend program execution for a given time, it is possible to prolong the day or night mode to max. 24 hours. To do so:



Press the  key for 3 seconds. Then, using the knob, set the number of manual operation hours (max. 24 hours) and confirm setting with the  key.

The controller will wait to set what of the two temperatures should be held (day or night). Press the  key or use the knob to change the setting. Press the  key to acknowledge the selection.



Option 2

If, for some reasons, you would like to suspend program execution, for example because of a longer party, and the controller has already started to decrease temperature for the night setting (the symbol  is displayed), and you wish to keep comfortable temperature till the party ends:



Press the  key, and the  and  symbol will be displayed. The day temperature will be kept for as long as the next temperature change is made by the program.

To switch this function off, press the  key, then the  symbol will disappear.

Similarly, if you are leaving your house for a longer time, then:

Press the  key, and the  and .

The night temperature will be kept for as long as the next temperature change is made by the program.

To switch this function off, press the  key, then the  symbol will disappear.

Anti-freeze temperature ❄️

If you leave for a longer time, you can set the anti-freeze temperature. This will prevent from the consequences of freezing of water in the heating system by automatic temperature setting to 7°C. To set the anti-freeze program, select the program 0 at the desired day of week.

Controller RESET

Reset is done by removing the battery for as long as the data from the display disappears.

Controller MASTER RESET

MASTER RESET is done by pressing and holding the  key and putting the battery in at the same time.



This will reset the controller to defaults.

NOTE: All user programs will be deleted!

Configuration settings

Configuration settings are presented for changing in the following order:



To enter the configuration settings change mode press the,  buttons  simultaneously and hold them for 3 seconds until the display backlight starts flashing.

1. HEATING / AIR CONDITIONING MODE

The controller can work in two modes:



A heating mode (factory set) – it should be selected when the controller is to work with heating devices.



An air conditioning mode – it should be selected when the controller is to work with air conditioning devices.

The relevant mode can be selected by turning the knob counter-clockwise or clockwise. Confirm the choice by pressing . The controller switches to the next parameter change.

2. HYSTERESIS CHANGE

Hysteresis is designed to prevent switching the controlled device on and off too frequently due to minute fluctuations of temperature.

E.g. for the HI 2 hysteresis, when the temperature is set to 20°C, the boiler will be switched on at 19.8°C, and switched off at 20.2°C.

For the **HI 4** hysteresis, when the temperature is set to 20°C, the boiler will be switched on at 19.6°C, and switched off at 20.4°C.



The hysteresis change mode is signalled by flashing text HI. You can change hysteresis settings with turn the knob clockwise.

HI 4 – $\pm 0,4$ °C.

HI 2 – $\pm 0,2$ °C (factory setting)

Confirm the setting by pressing the **OK** button. The regulator will proceed to change the next parameter.

3. DELAY CHANGE

Delay is designed to prevent switching the controlled device on and off too frequently e.g. due to a momentary whiff of air caused by opening a window.

This mode is signalled by flashing text **90:SE**. Turn the knob clockwise to switch the delay on and off.



90:SE – 90s delay. (factory setting)

0:SE – without delay.

Confirm the setting by pressing the  button. The regulator will proceed to change the next parameter.

4. OFFSET CHANGE

Offset allows for calibrating temperature indications within the tolerance of $\pm 3^{\circ}\text{C}$. E.g. the temperature regulator indicates that the room temperature is 23°C , whereas a regular mercurial thermometer placed alongside indicates 24°C . Changing offset by +1 degree makes the regulator indicate the same temperature as the mercurial one.

The offset change mode is signalled by flashing text OFFS. You can set the desired value (turn the knob clockwise) within the range from 3.0 to 3.0 (factory setting is 0.0).

Confirm the setting by pressing the  button. The regulator will resume normal mode of operation.

NOTE: If no button is pressed for 10 s while changing configuration settings, the regulator will resume normal mode of operation.

NOTE: The first pressing of any function button always activates the backlight, and only then the next call of the button function.

Special situations

- When 3 consecutive transmissions (after 15 minutes) from the AURATON 3021R regulator are lost, an error is signalled on the RT receiver (LED flashing continuously red and green). The RT receiver starts executing the ON - OFF cycle memorised during the last 24 hours of operation until the problem is removed.
- When signal return (from the AURATON 3021R regulator), the error is cancelled and the receiver enters its normal mode of operation.

Unique features of AURATON 3021 RT

- Switching the relay is synchronised with the wave of the 230 V mains voltage in order to ensure that closing and opening contacts of the relay occurs around the zero-crossing point. This prevents the occurrence of an electric arc, significantly extending the relay service time.
- The RT receiver is equipped with a unique algorithm for analysing the ON - OFF cycles. The entire heating cycle from the last 24 hours is recorded in the memory of the RT receiver. In the event of losing communication with the AURATON 3021R regulator, the RT receiver automatically executes the ON - OFF cycle memorised during the last 24 hours. This provides time for restoring transmission (removing interferences) or fixing the 3021R regulator without a significant deterioration of thermal comfort conditions in the controlled spaces.

Additional information and notes

- The AURATON 3021R regulator must be installed at least 1 metre from the RT receiver (too strong a signal from the transmitters can cause interference).
- At least 30 seconds must elapse between switching the relay off and on. Data transmission from the AURATON 3021R regulator to the receiver occurs upon each change of 0.2 °C of the surrounding temperature. When the temperature is stable, the regulator sends heart-beat data every 5 minutes (which is signalled with the LED blinking orange on the RT receiver).
- In the event of a power outage, the RT receiver will switch off. When power is restored, the heating device is switched on automatically, and the RT receiver awaits a signal from the paired transmitters (this signal should be received within 5 minutes of restoring power). After receiving the signal, the RT receiver enters the normal mode of operation.
- The RT receiver cannot be placed in metal containers (e.g. an assembly box, a metal enclosure of a heater) in order to not to interfere with its operation.
- Pressing any function key for the first time always starts the backlight first, and then the key function is performed.

- While programming any function, if no key is pressed for 10 seconds, this will be interpreted as pressing the **OK** key.
- The control functions of the controller can be switched on and off (e.g. after heating season) by holding the **OK** key pressed for a while. *(The controller will display only the current time and temperature of the room - no „timeline“).*

Cleaning and maintenance

- Clean the outside of the device with a dry cloth. Do not use from solvents (such as benzene, thinner or alcohol).
- Do not touch the device with wet hands. It may cause electric shock or serious damage to the device.
- Do not expose the device to excessive smoke or dust.
- Do not touch the screen with a sharp object.
- Avoid contact of the device with liquids or moisture.

The RT receiver connection schematics

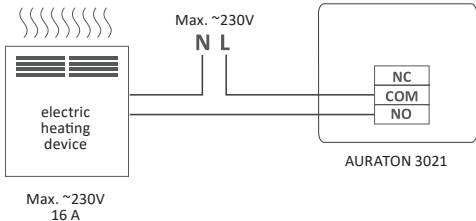
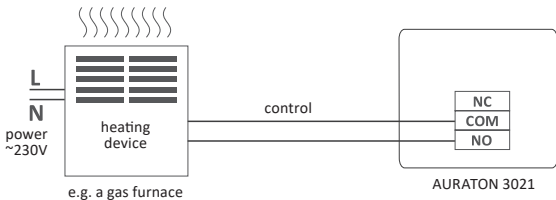

The AURATON 3021 regulator connection schematics

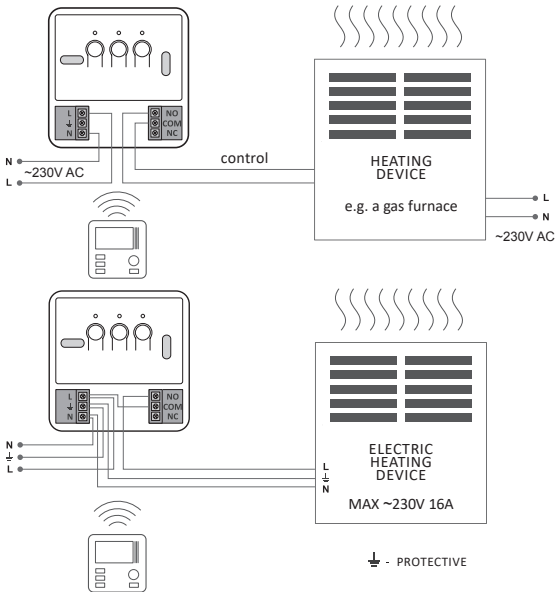

The controller in the Dual Sensor (DS) version (with an additional temperature sensor)

A controller fitted with an additional socket enables connecting an external temperature sensor (2.5 m is supplied). In order for the external sensor to be properly detected, first the sensor must be connected and then the supplied batteries must be installed in the controller.

After the controller with an additional sensor is switched on, it is possible to set the maximum temperature of the external sensor in the range of 10 to 55 deg. C.

In order to check the temperature of the external sensor measured by the controller, press the  button for a short time; the measured value will blink for 5 seconds

With the additional external sensor connected, the controller will maintain the temperature according to the air temperature (the temperature of the internal sensor) and the heating will be switched on until the temperature is reached by one of the sensors.

Heating may be switched off because a temperature of the external sensor is reached even though the air temperature is not reached (internal sensor).

The controller in the Dual Sensor version (with an additional temperature sensor) has the emergency transmitter operation function.

When the voltage battery is too low (the indicator on the display), the user may decide to switch the transmitter off or to switch it on permanently.

In the menu of the controller, the Pr OFF setting (transmitter switched off permanently) or Pr ON setting (transmitter switched on permanently) can be selected.

The controller maintains those settings until new batteries are installed (the low battery voltage indicator is switched off).

If the external sensor is disconnected or defective, the display shows two lines in the temperature measurement field and the controller switches automatically into the anti-freeze operation mode.



In such a case, a new external sensor must be installed or the controller must be reset by taking out the battery for several minutes, which causes the controller to switch into the mode of operation with an external sensor.

External temperature sensor

(AURATON 3021P i 3021 DS)

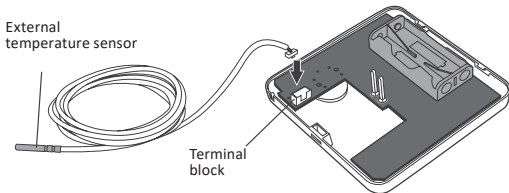
In AURATON 3021 P it is possible to connect an external temperature sensor with the 2.5m cable. In the default configuration the controller will display the temperature from the internal temperature sensor. The controller automatically switches to displaying the outside temperature when the external sensor is connected.



If the external sensor is disconnected or damaged, the controller goes to the emergency mode (dashes are displayed instead of temperature) which results in turning off the transmitter and then the controlled device. To leave the emergency mode, reconnect or reset the controller by pressing and holding two buttons simultaneously:  and .

After that, the controller will return to displaying the temperature from the internal sensor.

Technical data

Operating temperature range:	0 – 45°C
Temperature measuring range:	0 – 35°C
Temperature control range:	5 – 30°C
Range of temperature control of the external sensor:	10 – 55°C
Hysteresis:	±0,2°C / ±0,4°C
Default temperature settings:	day 21°C / night 19°C
Additional function:	Anti-freeze mode
Operating cycle:	Weekly
Operating mode control:	LCD
Maximum load current of the relay contacts:	resistive 16 A inductive / capacitive 10 A
Power supply controller:	2 x AAA 1,5V alkaline battery
RT Receiver power supply:	230V AC, 50Hz
RT Receiver Radio frequency:	868 MHz
RT Receiver Operation range:	in a typical building, with standard construction of walls - approx. 30 m an open space – up to 300 m

Disposal considerations



The devices are labelled with the crossed out waste bin symbol. In accordance with the European Directive 2002/96/EC and the Act on Waste electrical and electronic equipment such marking indicates that the device, after a period of use, can not be disposed of together with other household waste.

You shall return the equipment to an electronic or electrical waste collection point.



CE

www.auraton.pl

ver. 20190213